

# A Politico-Economic Model of Aging, Technology Adoption and Growth\*

Francesco Lancia  
University of Bologna

Giovanni Prarolo<sup>†</sup>  
University of Bologna and FEEM

This version: February 2007  
VERY PRELIMINARY, PLEASE DO NOT QUOTE

## Abstract

Over the past century, all OECD countries have been characterized by a dramatic increase in economic conditions, life expectancy and educational attainment. This paper provides a positive theory that explains how an economy might evolve when the longevity of its citizens both influences and is influenced by the process of economic development. We propose a three periods OLG model where agents, during their lifetime, cover different economic roles characterized by different incentive schemes and time horizon. Agents' decisions embrace two dimensions: the private choice about education and the public one upon innovation policy. The theory focuses on the crucial role played by heterogeneous interests in determining innovation policies, which are one of the keys to the growth process: the economy can be discontinuously innovation-oriented due to the different incentives of individuals and different schemes of political aggregation of preferences. The model produces multiple development regimes associated with different predictions about life expectancy evolution, educational investment dynamics, and technology adoption policies. Transitions between these regimes depend on initial conditions and parameter values.

**JEL Classification:** D70, J10, O14, O31, O43.

**Keywords:** growth, life expectancy, human capital, systemic innovation, majority voting.

---

\*We would like to thank Carlotta Berti Ceroni, Graziella Bertocchi, Matteo Cervellati, Oded Galor, Andrea Ichino, Gianmarco Ottaviano and David Weil for very helpful comments and suggestions as well as seminar participants at the University of Bologna macro lunch for very helpful discussions. All errors are our own.

<sup>†</sup>Corresponding author: prarolo@spbo.unibo.it University of Bologna, Strada Maggiore 45, 40125 Bologna.

# 1 Introduction

Over the recent past—no more than two hundred years—the Western World has experienced an extraordinary change in the economic environment and in all aspects of human life. We can observe that, in this period, all OECD countries have experienced a dramatic increase both in the longevity of their citizens and in the aggregate and per capita income. Simultaneously, the traditional social environment changed profoundly: the proportions of the population that were educated, and that were retired, increased significantly, causing the proportion of working people to shrink.

Looking at the details, we can stress some qualitative and quantitative facts behind these features of the economies. Life expectancy in the last century and a half increased tremendously: in 1850 it was below 60 years in US (Lee, 2001) and around 40 in England (Galor, 2005), while today it almost reaches 80 years (Fogel, 1994). At the same time, both the shares of lifetime that people devoted to education and retirement increased. In 1850 the percentage of people enrolled in primary education was less than 10%, so, on average, the time devoted to schooling was negligible. Now people, adding up informal (child caring carried out by parents) and formal schooling, study for around 20 years, one quarter of their expected lifetime. The participation of people in retirement shows similar trends: in 1850 less than three years were devoted to retirement, while today, especially in Europe, thanks in particular to the introduction of social security systems after World War II, people retire for almost 20 years:<sup>1</sup> again, one quarter of their lifetime (Latulippe, 1996).<sup>2</sup> In figure 1 we show how life expectancy and its components, in terms of economic roles of people, evolved in the last century and a half, for the USA. In Europe some trends presented here are even more evident: in particular, life expectancy increased more rapidly (from a lower level to a higher level than in the US) and retirement length increased more.

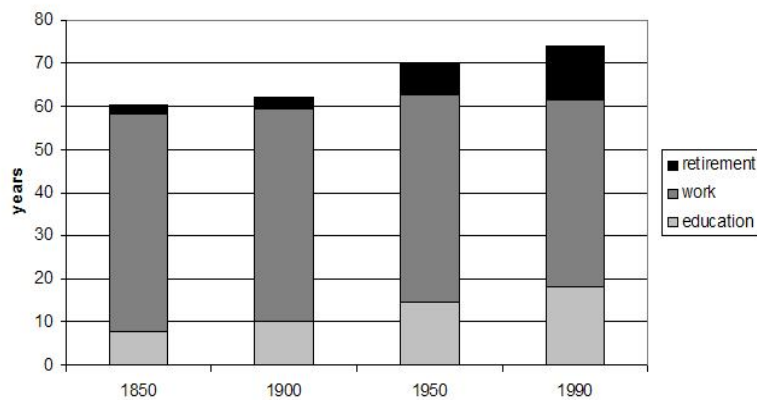

Fig.1. Life expectancy and economic roles in the US. Source: Lee (2001), www.bls.gov, and our calculations.

<sup>1</sup>All data come from www.census.org and our calculations.

<sup>2</sup>For European data see Galasso and Profeta (2004).

One of the most important implications of these trends is that developed countries are changing their political structures, moving from a form of "*workers' dictatorship*" to a more diluted political representation: the voices of both young and retired people in the political debate continually increase, and intuitively their interests should not coincide with the interests of adult workers. This almost certainly impacts on the composition of the aggregate demand. Consider, for example, the increasing demand for expenditure in health care for elderly people, residential structures for retired people, old age entertainment, etc. Here we are, however, interested in the production side of the economy, specifically in the mechanisms that run from individual and aggregate preferences to the production process and which could be affected by demographic, and therefore political, changes. A conflict of interests among age classes, in terms of production choices, will probably arise between workers and students, if these are innovation-prone, and retired people, who are not interested in technological innovation, since their real income is not tied to their own labour income, which is linked to the *past* innovation choices. Moreover, a conflict of interests can also arise between young people and adults: for the former innovation has long lasting effects, since it affects both their productivity in the labour market once they will be adult and their children's capacity to acquire human capital. For the latter, a new technology impacts on the ability of their children to pay them a pension. These different incentive schemes would hardly be identical.

Since our theory rests on the idea that human capital and technology are the two engines that boost economic growth,<sup>3</sup> we analyze how a longer life expectancy affects the dynamics of these two variables. In this framework we analyze, by means of a three-periods overlapping generation model in which life expectancy endogenously changes, the interactions among education, technological change, aging and growth.<sup>4</sup> What we have in mind are the potential conflicts of interests that arise among different generations. Due to different time horizons and economic incentives, individual and aggregate choices can endogenously change because of the demographic evolution of population.

The purpose of this work is to provide an illustration of how an economy might evolve when life expectancy mainly affects both private and public choices concerning the production side of the economy and, therefore, the growth process. The paper is organized as follows. In section 2 we specify what we consider "systemic innovation". Section 3 presents the model. Section 4 contains a simple dynamic example. Section 5 concludes.

---

<sup>3</sup>It has been increasingly recognized that both human capital formation and technological changes play important roles in economic growth (Lucas, 1988; Romer 1986). That is, the improvement of knowledge and skills embodied in labour, as well as changes in technology, mostly embodied in physical capital, determine the potential for moving the production frontier outward.

<sup>4</sup>Recent studies have shown, at least theoretically, that economic growth is helped by an increase in life expectancy (Galor and Weil, 1998; Blackburn and Cipriani, 2002; Cervellati and Sunde, 2005).

## 2 Systemic Innovation

Innovation is a discontinuity in knowledge and, therefore, in production techniques, whose outcome is an appreciable increase in productivity. With the same resources the system is capable of producing more goods, or it is capable of producing the same quantity of goods with less resources. We refer to a systemic innovation<sup>5</sup> as to a type of innovation that, in order to be implemented, has to pass through the endorsement of a political mechanism, where, in general, the interests of different groups of agents (consumers, producers, the government, high/low skill groups, etc.),<sup>6</sup> do not coincide. The public nature of systemic innovation, in contrast with the Schumpeterian view of innovations developed by firms running for the best cost-saving technology, comes from the historical point of view where the implementation of a new technology is rarely the outcome of pure profit-maximizing by firms.

The public nature of systemic innovation requires a different innovation model in comparison with linear ones based on R&D and, consequently, on innovation and technological transfer. Accordingly to Mansell and When (1998), the systemic innovation model can be defined as a “*chain model*”, characterized by interdependence between both the development of knowledge and its application to the production processes and negotiation of interests among different agents. Innovation used to be a linear trajectory from new knowledge to new product, now it becomes neither singular nor linear, but systemic. It arises from complex interactions between many individuals, organizations, and their operating environment.

Following the historical point of view delineated by economists like Mokyr (1998a, 2002) and Olson (1982), in this study we focus our attention on systemic innovation as a growth-enhancing technology. Bauer (1995) points out that a decentralized market outcome seems to be a poor description of many technology breakthroughs. Economic convenience is certainly not irrelevant, but, as Mokyr (1998a) suggests: “*there usually is, at some level, a non-market institution that has to approve, license or provide some other imprimatur without which firms cannot change their production methods. The market test by itself is not always enough. In the past, it almost never was.*” (p. 219) Thus, as reported by Olson, the decision whether to adopt a new technology is likely to be resisted by those who lose by it through some kind of activism aimed at influencing the decision by the above-mentioned institutions.

Consequently, we construct a model in which, for endogenous reasons, technology adoption is delegated to a regulatory institution, the democratic vote. We formalize the idea that an innovation, before being introduced in large-scale production, has to be approved by some non-market institution. Its adoption

---

<sup>5</sup>We take it that there is no uncertainty in the outcome of a new technology of this kind: once the decision to shift to the new technology is undertaken, with probability one a productivity enhancement takes place. It follows that we are not dealing with risky process of producing new ideas, but with the process of implementing existing ideas in new ways that are more efficient, although not for everybody in the same way.

<sup>6</sup>In our framework the contrast evolves among different age groups.

is *ex-post* disposable for all individuals in the economy, but *ex-ante* the choice to adopt it or not can be affected by the interests of different age groups. According to Bellettini and Ottaviano (2005), the central authority can be seen as a licensing system that has some agency to approve new technologies before they are brought to the market. Again in Mokyr (1998a)'s words: "*almost everywhere some kind of non-marketing control and licensing system has been introduced*". A recent example is the creation of standard-setting agencies such as the International Organization of Standardization (ISO) or, about property rights, the European Patent Office (EPO).

To capture the evolving clash between resistive and innovative interests, we consider an economy that, at any point in time, is populated by three different overlapping groups of agents differing in terms of their life horizons and incentives schemes. In fact, besides the increasing human capital accumulation, productivity improvements come from the innovation process. A systemic innovation is implemented if and only if there is a political consensus for it: because its net benefits are not equal among the different age classes, in a heterogeneous setting there is always room for suboptimal provision of the innovation itself. Among different political mechanisms (majority vote, lobby intervention and so on) for implementing a new innovation, according to Krusell and Rios-Rull (1996) as well as Aghion and Howitt (1998), we assume that the public choice is carried out by means of a democratic majority voting where the interests of the absolute majority of the population prevail.

### 3 The model

Time is discrete and indexed by  $t \in \mathbb{N}^+$ . The economy is populated by homogeneous agents of measure one living up to three periods: they survive with probability one from youth to adulthood and with probability  $p_t$  to old age. When people of generation  $t$  are young they split their unit time endowment between schooling ( $e_t$ ) and working as unskilled ( $1 - e_t$ ), using the average human capital that their parents bequeathed them (in the form of an externality). Their income is linear in human capital and is, in case, taxed for a new productive technology to be implemented in the next period.<sup>7</sup> From now on, we call this operation of taxation simply innovation tax. It is a fix share of income and takes the values  $i$ ,  $0 < i < 1$ , or zero in case innovation is decided or not, respectively. As adults, each of them has a single child. Adults' human capital is a function of past human capital and the effort they made when young. They combine their human capital with a TFP parameter that increases if a new technology is endorsed the period before. Their income is divided between consumption, a constant share  $s$  that goes, in a PAYGO fashion, in paying their parents' pensions<sup>8</sup> and, in case, the innovation tax  $i_{t+1}$ . When old, they

<sup>7</sup>Using a school/leisure choice it would have been difficult to introduce the tax on innovation.

<sup>8</sup>We do not discuss the way in which the pension system is implemented and if it can be politically self-sustaining, as Bellettini and Berti Ceroni (1999) do. We assume instead that a

consume the pension that their children pass to them, net of the innovation tax  $i_{t+2}$ . The complete scheme of the timing for an agent born at time  $t$  is represented in figure 2.

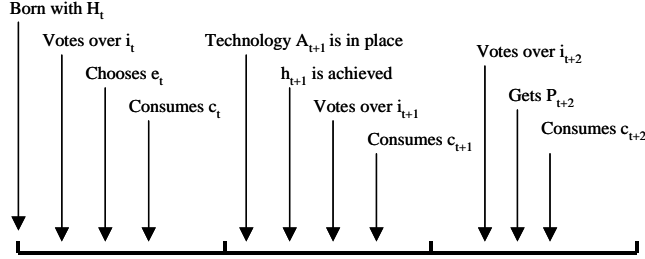

Agents' political lever is characterized by their ability to vote, every period of their life, for a systemic innovation to be implemented in the next period. In order to take into account the increasing and, in some cases, crucial power of old retired, we assume that young people show a lower turnout rate with respect to adults and old.<sup>9</sup> Thus, their weight in the political process is represented by an exogenous parameter  $\eta \in (0, 1]$ . All adults and old can vote, so their measure is 1 and  $p_t$ , respectively, where  $p_t$  is the share of old alive.

Production output is undertaken by firms: competitive firms employ the human capital supplied by agents as the only input, using a technology  $A_t$ , taken as given and out of their control.

### 3.1 Utility, budget constraints and production functions.

The expected lifetime utility for an agent born at time  $t$  (1) is non altruistic and its arguments are the consumption levels in the three periods.  $\alpha \in (0, 1)$  is the usual discount parameter, while  $p_t$  is the probability to survive in old age. In this subsection, despite the time suffix, we consider  $p_t$  as a constant. Thus, we could just write  $p$ , but below we will endogenize it and it will be important for the analysis to let this variable change over time.

$$u_t = \log c_t + \alpha \log c_{t+1} + p_t \log c_{t+2} \quad (1)$$

The budget constraints in the three periods are as follows. Note that in every period the incomes are taxed in case a new technology is decided to be implemented in the next period.

$$c_t = H_t(1 - e_t)(1 - i_t) \quad (2)$$

$$c_{t+1} = y_{t+1}(1 - s - i_{t+1}) \quad (3)$$

commitment between generations is in place and no one can default on it.

<sup>9</sup>Galasso and Profeta (2004) report that the turnout rate among people aged 60-69 relative to people 18-29 is double in the US and 50% higher in France.

$$c_{t+2} = P_{t+2}(1 - i_{t+2}) \quad (4)$$

Production of final good in the skilled sector (i.e. by adult) takes the form of a decreasing return function of human capital (6). The TFP parameter  $A_t$  is equal to  $A_{t-1}$  in case a new technology is not implemented ( $i_{t-1} = 0$ ), while  $A_t = (1 + \theta)A_{t-1}$ ,  $\theta > 0$  in case a new technology is implemented ( $i_{t-1} = i$ ). At time  $t = 0$ ,  $A_t = A_0 = A$ . A compact formulation for  $A_t$  is:

$$A_t = \left(1 + \theta \frac{i_{t-1}}{i}\right) A_{t-1} \quad (5)$$

where  $\theta$  denotes the growth rate of the technology and is a strictly positive scalar. The straightforward expression for skilled production at time  $t$  is as follows, with  $0 < \gamma < 1$ :

$$y_t = A_t h_t^\gamma = A_{t-1} \left(1 + \theta \frac{i_{t-1}}{i}\right) h_t^\gamma \quad (6)$$

Human capital of an adult born at time  $t$  (7) increases with the human capital with which she is born ( $H_t$ ) and the effort she exerted in schooling when young ( $e_t$ ). The human capital depreciates by a factor  $(1 - \delta)$  in case an innovation is decided at time  $t$ . The assumption is that when new technologies are implemented, human capital produced in schools based upon previous types of technology is less useful (Boucekkine et al., 2002, 2005). Ranges for the parameters are  $\lambda > 0$ ,  $0 \leq \delta < 1$  and  $0 < \epsilon < 1$ .

$$h_{t+1} = \lambda \left( (1 - \delta \frac{i_t}{i}) e_t H_t^\epsilon \right) \quad (7)$$

At the same time, an old of generation ( $t - 2$ ) receives (8) that is the share  $s$  of income that an adult of generation ( $t - 1$ ) disbursed in the PAYGO system, multiplied by the coefficient  $p_t^{-1}$  that takes into account the share of people surviving to old age.

$$P_t = \frac{sy_t}{p_t} = \frac{sA_t h_t^\gamma}{p_t} \quad (8)$$

### 3.2 Individual optimization with given innovation policy

In every period of her life an agent takes as given the innovation policy. We will add the case of majority voting on the innovation policy later. Agents choose the schooling time when young. From the first order condition  $\frac{\partial u_t}{\partial e_t} = 0$  we obtain the optimal schooling time:

$$e_t^* = \frac{\gamma[\alpha + \epsilon p_t]}{1 + \gamma[\alpha + \epsilon p_t]} \quad (9)$$

It is easy to find a positive relationship between  $p_t$  and the equilibrium value of  $e_t$ : the longer is the life expectancy of people, the higher is the time

investment needed to finance their prolonged consumption, consistently with existing literature. Substituting (9) in (7) and writing  $h_t$  instead of  $H_t$  (due to straightforward equilibrium considerations) we get the accumulation function of human capital as a function of past human capital, the innovation policy chosen the period before and the fraction of time youth spend in education. At time  $t$  we obtain:

$$h_{t+1} = \lambda \left( 1 - \delta \frac{i_t}{i} \right) \frac{\gamma[\alpha + \epsilon p_t]}{1 + \gamma[\alpha + \epsilon p_t]} h_t^\epsilon \quad (10)$$

The human capital accumulation function shows the usual concave shape (given that  $0 < \epsilon < 1$ ) and the role of human capital depreciation in the case of innovation,  $(1 - \delta \frac{i_t}{i})$ , is clear. Moreover, the human capital augmenting effect of life expectancy can be evaluated by looking at the expression of  $e_t^*$ .

### 3.3 Endogenous life expectancy

In this subsection we allow for the level of life expectancy to increase with the aggregate human capital level as in, among others, Blackburn and Cipriani (2002) as well as Cervellati and Sunde (2005).<sup>10</sup> The probability to reach old age is, therefore,  $p_t = p(H_{t-l})$ , where  $l$  is a lag of at least two periods for ensuring that people are not internalizing changes in life expectancy when optimizing their human capital level. We impose some restrictions on  $p(H)$ , in order to get simple results.  $p(0) = p_0 > 0$  avoids the extreme case of a disappearing old age, while  $\frac{\partial P(H)}{\partial H} = p_H > 0$  replicates the empirical evidence of a positive correlation between life expectancy and education. Because  $p$  is a probability, we assume that  $\lim_{H \rightarrow +\infty} p(H) = p^L \leq 1$ . Simple algebra and the equilibrium identity  $h_t = H_t$  allow us to rewrite the expression of human capital accumulation (10):

$$h_{t+1} = \Gamma_1(h_t; i_t) h_t^\epsilon$$

The function  $\Gamma_1$  is always greater than zero, increasing in  $h$  and, for the restrictions imposed on the function  $p$ , limited from above by some finite number. In the case of both innovation and no innovation it is possible to show that multiple finite equilibria can arise, as we show in figure 3. In this figure we represent the case of innovation, where  $i_t = i$ :  $h^{S1}$  and  $h^{S2}$  are stable equilibria, while  $h^{U1}$  is the unstable equilibrium. Of course, in the case of innovation the whole graph of  $h_{t+1}$  lies below the one of no innovation: it can be, therefore, the case

<sup>10</sup>Empirically, both private and aggregate endowment of human capital are conducive to a longer life, although we focus on the aggregate view: on the one hand, demographic and historical evidence suggests that the level of human capital profoundly affect the longevity of people. For example, the evidence presented by Mirowsky and Ross (1998) supports strongly the notions that better educated people are more able to coalesce health-producing behaviour into a coherent lifestyle, are more motivated to adopt such behaviour by a greater sense of control over the outcomes in their own lives, and are more likely to inspire the same type of behaviour in their children. Schultz (1993, 1998) evidences that children's life expectancy increases with parent's human capital and education. On the other hand, there is evidence that the human capital intensive inventions of new drugs increases life expectancy (Lichtenberg, 1998, 2003) and societies endowed with an higher level of human capital are more likely to innovate, especially in research fields like medicine (Mokyr, 1998b).



that if innovation takes place there is room, due to the depreciation of human capital, for two stable steady states, while in the case of no innovation only one stable steady state arises. In figure 4 we show the case of no innovation ( $i_t = 0$ ): the graph of  $h_{t+1}$  is higher and only one stable steady state,  $h^{S3}$ , arises.

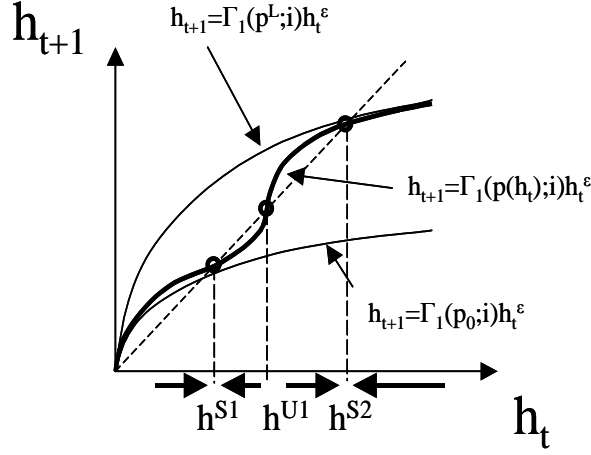

Fig.3. Equilibria of human capital level in the case of innovation and endogenous life expectancy.

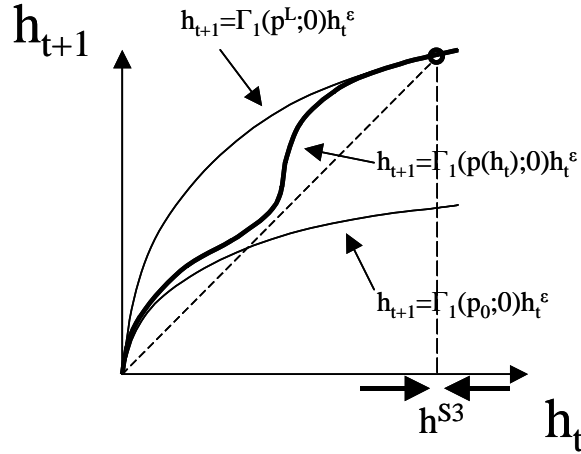

Fig.4. Equilibrium of human capital level in the case of no innovation and endogenous life expectancy.

Apart from the innovation policy, increases of  $\alpha$ ,  $\lambda$ ,  $\gamma$  and  $\epsilon$  shift  $h_{t+1}$  upward, leading both to higher level of human capital for any steady state and to the disappearance of the low steady state,  $h^{S1}$  in figure 3.

The fact that (i) the growth of human capital is bounded from above and (ii) human capital is the only factor of production and its accumulation function

does not depend upon the *value* of the TFP parameter allows us to study, in an "additive" way, how human capital and production evolve. For example, once human capital reaches a steady state, using (6) we can keep track of the final production just looking at the innovation policy undertaken. Therefore the steady state production is a constant level in the case of no innovation ( $y^* = A_0(h^{S^*})^\gamma$ ), while it will be an increasing level (at the constant rate  $\theta$ ) in the case of innovation ( $y_t = A_0(1 + \theta)^t(h^{S^*})^\gamma$ ). The value  $h^{S^*}$  represents one of the stable steady states that we can find in figure 3 or 4.

### 3.4 Endogenous innovation policy

Up to this point the innovation policy has been taken as given, either innovation or no innovation, and the same in every period. From now on we will use, when necessary,  $I$  or  $N$ , respectively. Now we allow agents to vote upon the innovation policy, and the decisions aggregate by means of a majority mechanism. With our setup the shares of young, adult and old voters are  $\frac{\eta}{\eta+1+p_t}$ ,  $\frac{1}{\eta+1+p_t}$  and  $\frac{p_t}{\eta+1+p_t}$ , respectively. The more the life expectancy increases, the more important is the relative weight of old and the less important are the weights of young and adult in the political process.

**Proposition 1** *For values of life expectancy smaller than*

$$\hat{p} = 1 - \eta$$

*a "workers' dictatorship" arises: no matter what young and old prefer, adult alone will set the agenda in terms of innovation. There are no values of  $p_t$  such that another form of dictatorship (i.e. a single age group has the absolute majority) can arise.*

**Proof.** Adult get the absolute majority if and only if their share is bigger than  $\frac{1}{2}$ : imposing  $\frac{1}{\eta+1+p_t} > \frac{1}{2}$  we obtain, solving for  $p_t$ , the expression in the proposition. For similar considerations it is possible to show that both  $\frac{\eta}{\eta+1+p_t}$  and  $\frac{p_t}{\eta+1+p_t}$  can not exceed  $\frac{1}{2}$ . ■

In early stages of development process the political power is, therefore, in the hands of adult alone, while the more the human capital increases, the longer life expectancy is and the smaller the share of adult is. It can be the case that  $p_t$  exceeds  $\hat{p}$ : from this moment on decisions about innovation need the consensus of two age groups over three, so the political process becomes a little more complex. We call this stage "*diluted power*". The specific cost-benefit setup of the innovation implies that old people are always against innovation: they are supposed to pay today a fraction of their income for a new technology that will be available once they are dead. This simplifies our analysis: in the case of "*workers' dictatorship*" this feature is not influential, since only adult decide, while in the case of  $p_t > \hat{p}$  we need to know, to be sure that innovation will be voted, whether both adult and young will vote for  $I$ . Otherwise  $N$  will be the implemented policy.

Our strategy is to check, for all the three-period sequences of policies,<sup>11</sup> if agents' vote and policy outcome is consistent with the configuration under analysis. Let us now define some variables that will be useful in the policy setting framework and describe agents' behaviour in the three different stages of their life.

We call  $v_t^j$  the choice of innovation policy voted by an agent of type  $j$  (with  $j \in J = \{Y; A; O\}$ ) at time  $t$  and it can take the values  $\{\iota, \nu\}$ , that stand for innovation and no innovation, respectively. Note that old's choice is always to vote against innovation, as will be clear below:  $v_t^O = \nu, \forall t \in \mathbb{N}^+$ . In every period the function  $M_t$  aggregates the votes of the three generations alive and its outcome is the majority choice:

$$M_t(v_t^Y; v_t^A; v_t^O) = \begin{cases} I & \text{if } \begin{cases} v_t^Y = v_t^A = \iota \text{ and } p_t > \hat{p} \\ v_t^A = \iota \text{ and } p_t < \hat{p} \end{cases} \\ N & \text{otherwise} \end{cases} \quad (11)$$

A new innovation will be, therefore, implemented at time  $(t + 1)$  if and only if  $M_t = I$ .

Now the optimization problem for the agent is to vote, in every period of her life, upon the innovation policy and, taking the outcome of the voting mechanism in every periods as given, to allocate her youth time between schooling and working. We study the choice of the three generations backward, from the old to the young, at time  $t$ . Thus, the individuals under analysis are old agents born at time  $(t - 2)$ , adult agents born at time  $(t - 1)$  and young born at time  $t$ . The time structure of our political problem can be represented in figure 5.

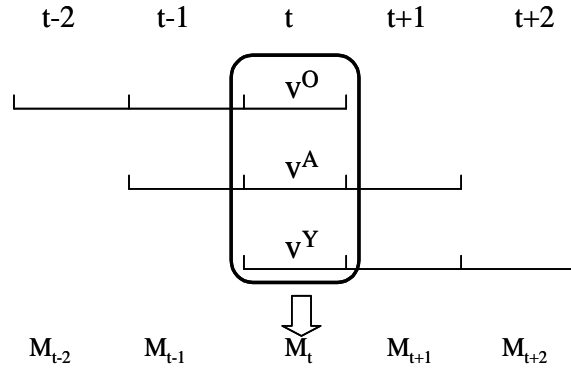

Fig.5. Scheme of votes aggregation.

<sup>11</sup>Being the two states of voting variable  $\{I; N\}$  and the three periods that an agent live, the possible streams of policies are  $2^3 = 8$ :  $\{I_t; I_{t+1}; I_{t+2}\}$ ;  $\{I_t; I_{t+1}; N_{t+2}\}$ ;  $\{I_t; N_{t+1}; I_{t+2}\}$ ;  $\{I_t; N_{t+1}; N_{t+2}\}$ ;  $\{N_t; I_{t+1}; I_{t+2}\}$ ;  $\{N_t; I_{t+1}; N_{t+2}\}$ ;  $\{N_t; N_{t+1}; I_{t+2}\}$ ;  $\{N_t; N_{t+1}; N_{t+2}\}$ .

### 3.4.1 Old

As we stated above, old people, in the case of innovation policy, only incur in costs: once the new technology is in place, they will be dead. Their optimal choice is always to vote against, since  $v_t^O$  is their only choice that has to be made. Moreover, they do not need to anticipate future political outcomes.

### 3.4.2 Adult

When adult, agents vote over the innovation that will be implemented next period. In principle, the decision to vote for an innovation or not depends on the differential utility that has to be computed for every future outcome of the majority choice  $M_{t+1}$ . Due to the functional form of the utility, adult do not care about tomorrow's outcome of the innovation policy: income and substitution effects cancel out for what concerns tomorrow's cost of innovating. They decide to innovate, iff:

$$\Delta u_t^A(M_{t+1} = I) = \Delta u_t^A(M_{t+1} = N) = u_t^A(v_t^A = \iota) - u_t^A(v_t^A = \nu) > 0 \quad (12)$$

where  $u_t^A$  depends on  $h_{t-1}$  and  $M_{t-1}$ . Writing explicitly (12), we find:

$$\Delta u_t^A = \alpha \log(1 - i - s) + p_t \log(1 + \theta) + p_t \gamma \log(1 - \delta) - \alpha \log(1 - s) > 0 \quad (13)$$

Let us assume from now on that  $\theta > (1 - \delta)^{-\gamma} - 1$ : this condition on the relative magnitude of TFP improving parameter and human capital depreciation parameter states that, in the case that an innovation takes place, the improvement in the production of final good exceeds the worsening of the quality of human capital used in production. Algebraically, this condition makes the denominator of  $P^A$  to be positive. It is easy to show that the same consideration will be effective also for  $P^Y$ , which we will define in the next paragraph. Moreover, note that  $\lim_{i \rightarrow 0^+} p^A = 0$  and  $\lim_{i \rightarrow (1-s)^-} p^A = +\infty$ .

In (13), under the assumption above, adults enjoy a higher utility, in the case of innovation, the higher is their life expectancy: they experience a benefit from the technology parameter  $\theta$  that augments, *proportionally with*  $p_t$ , their pension when old. Conversely, they experience a cost, proportional with  $p_t$ , from the depreciation of their children's human capital (even though this cost is mitigated by the elasticity of human capital in the production of the final good).

Simple calculations lead to the following expression, where  $p^A$  is the value of life expectancy above which adults are in favour of innovation:

$$p_t > \frac{\alpha \log\left(\frac{1-s}{1-s-i}\right)}{\log(1 + \theta) + \gamma \log(1 - \delta)} \equiv p^A \quad (14)$$

Adults vote for an innovation if and only if they will get higher resources (net of innovation costs) when old, in the form of pensions paid by their children<sup>12</sup>.

<sup>12</sup>In the meantime, adult's children are became adult themselves.

The threshold  $P^A$  is a positive function of  $i$ : the more expensive the adoption of a new innovation is, the less the adult will be innovation-prone. The same consideration holds for  $\delta$ : due to the adoption of a new technology, the more the human capital depreciates, the less the adult will be in favour of implementing the new technology itself. Conversely, an increase in the growth rate of TFP is conducive for a new technology to be preferred by adult. Note that the elasticity of past human capital in the production of the new human capital ( $\epsilon$ ) is not involved in adult's decisions: we will see below that only young take into account how the past level of human capital affects the next period's human capital accumulation. The higher the share is of adult's income going to finance old's pensions, the less the adult will vote for innovation.<sup>13</sup> The more people are oriented toward adult age consumption (i.e. for high values for  $\alpha$ ), the less they will be in favour of innovation. Lastly, an increase in the elasticity of human capital in the production of final good ( $\gamma$ ) works against innovation: to innovate is to make a part of human capital achieved during youth depreciate, and the higher its effectiveness in production is, the higher the loss is in terms of pensions paid by adult.

### 3.4.3 Young

Young vote over innovation taking into account both  $M_{t+1}$  and  $M_{t+2}$ , so in principle there are four possible future configurations:  $\{I_{t+1}; I_{t+2}\}$ ,  $\{I_{t+1}; N_{t+2}\}$ ,  $\{N_{t+1}; N_{t+2}\}$  and  $\{N_{t+1}; I_{t+2}\}$ . For the same argument stated above, what will happen at time  $(t+1)$  and  $(t+2)$  does not influence young's vote today. Thus, they only base their decision on achieved state variables. The condition under which young will be in favour of innovation is:

$$\begin{aligned} \Delta u_t^Y(M_{t+1} = I; M_{t+2} = I) &= \Delta u_t^Y(M_{t+1} = I; M_{t+2} = N) = & (15) \\ &= \Delta u_t^Y(M_{t+1} = N; M_{t+2} = N) = \Delta u_t^Y(M_{t+1} = N; M_{t+2} = I) = \\ &= u_t^Y(v_t^Y = \iota) - u_t^Y(v_t^Y = \nu) > 0 \end{aligned}$$

and again  $u_t^Y$  depends on  $h_{t-1}$  and  $M_{t-1}$ . An explicit expression of (15) is:

$$\Delta u_t^A = \log(1-i) + \alpha \log(1+\theta) + \alpha\gamma \log(1-\delta) + p_t \log(1+\theta) + p_t \epsilon \gamma \log(1-\delta) > 0 \quad (16)$$

Here young, in case of innovation, again directly benefit from the technologic parameter  $\theta$ , but now it impacts both their labour income when adults and the pension benefits when retired. In this last case the benefit from innovation is proportional to  $p_t$ , so a longer life gives more time to enjoy higher consumption. The cost structure is similar: a constant cost is due to the depreciation of human capital when young become adults, through a smaller marginal productivity in the production of final good. Another cost, proportional to  $p_t$ , takes into account the depreciation of human capital of young's children: two periods later, in

<sup>13</sup>There is a strand of literature that studies how pension systems are implemented, why they are so big, which policies are enforceable in this context, etc. For simplicity we take  $s$  as given, but we think this could be one of the first improvements to our work.

fact, today's young will get a pension that will be, in terms of human capital, depreciated because of today's choice to innovate. Therefore the depreciation term is mitigated by two terms,  $\epsilon$  and  $\gamma$ : the first takes into account the elasticity between the production of new human capital and the past stock of human capital, the latter the elasticity of human capital in the production of final good.

Simple calculations lead to the expression of  $p^Y$ , the value of life expectancy above which young are in favour of innovation:

$$p_t > \frac{-[\log(1-i) + \alpha \log(1+\theta) + \alpha\gamma \log(1-\delta)]}{\log(1+\theta) + \epsilon\gamma \log(1-\delta)} \equiv p^Y \quad (17)$$

Young's choices over innovation shows similar determinants as adult's. Again the threshold level is negatively correlated with the TFP growth rate ( $\theta$ ) induced by innovation. The depreciation of human capital in the case of innovation ( $\delta$ ) is a factor that discourages young, as long as adult, to vote for innovation. Moreover, with the assumption about the sign of the denominator made above, we can state what follows.

**Proposition 2** *For small values of the innovation costs young are in favour of innovation, whatever value the other parameters take.*

**Proof.** We need that  $p^Y < 0$  for some small values of  $i$ . With the assumption that  $\log(1+\theta) + \gamma \log(1-\delta) > 0$ , being  $\log(1-\delta) < 0$  and  $0 < \epsilon < 1$ ,  $\log(1+\theta) + \epsilon\gamma \log(1-\delta) > 0$  and  $0 < \frac{\log(1+\theta) + \gamma \log(1-\delta)}{\log(1+\theta) + \epsilon\gamma \log(1-\delta)} < 1$ . Since  $p^Y(i)$  is continuous and increasing in  $0 < i < (1-s)$  and  $\lim_{i \rightarrow 0} p^Y = -\alpha \left( \frac{\log(1+\theta) + \gamma \log(1-\delta)}{\log(1+\theta) + \epsilon\gamma \log(1-\delta)} \right) < 0$ , the proposition is proved. Moreover, if  $\lim_{i \rightarrow (1-s)} p^Y(i) < 0$ , young are in favour of innovation for any value of innovation costs. ■

The effect of the elasticity of past human capital in the production of human capital ( $\epsilon$ ) can be, in principle, either negative or positive. The interesting range of  $p^Y$  is, however, the positive one: here  $\frac{\partial p^Y}{\partial \epsilon} > 0$ . A high inertia in the transmission of human capital from one generation to the other leads to less interest in innovation because, as in Boucekine et al. (2002), human capital depreciates and the more it ages, the more its obsolescence makes it less productive. Conversely to the case of adult, for young a higher concern for adult age consumption  $\alpha$  is conducive to innovation: since they can, innovating, boost the production in adult age, they are in favour of new technologies.

### 3.5 Political outcome

We now deal with the political analysis: we show, for different parameters' ranges and initial conditions of life expectancy, which innovation policy is undertaken and which policy implications are implied. In table 1 we resume the partial effects that the single parameters have on the thresholds we defined above, in particular  $p^A$ ,  $p^Y$  and  $\hat{p}$ . They correspond to the value of life expectancy above which adults are in favour of innovation, young are in favour of

innovation and the value below which adults alone choose (since they represent the absolute majority of the constituency), respectively.

	$p^A$	$p^Y$	$\hat{p}$
$\eta$	0	0	-
$\alpha$	+	-	0
$\theta$	-	-	0
$i$	+	+	0
$\delta$	+	+	0
$\gamma$	+	+	0
$\epsilon$	0	+	0
$s$	+	0	0

Tab.1. Partial effects of parameters on thresholds.

In fig. 6, we represent, for generic values of parameters, the function (11) indicating which are the choices of agents. Shaded areas represent the sets in the space  $\{i, p_t\}$  in which innovation is undertaken. Since  $v_t^O = \nu, \forall t \in \mathbb{N}^+$ , we only report on the graph the choice vector of adult and young,  $Ct = (v_t^A; v_t^Y)$ . Resuming, below the line  $\hat{p}$  adult choose the policy, no matter what young choose. Above  $p^A$  and  $p^Y$  adult and young are in favour of innovation, respectively. Note that above  $\hat{p}$ , in order to implement an innovation, both adult and young have to be innovation-prone. On the horizontal axis we put the cost of innovation, while on the vertical axis we have the life expectancy at time  $t$ .

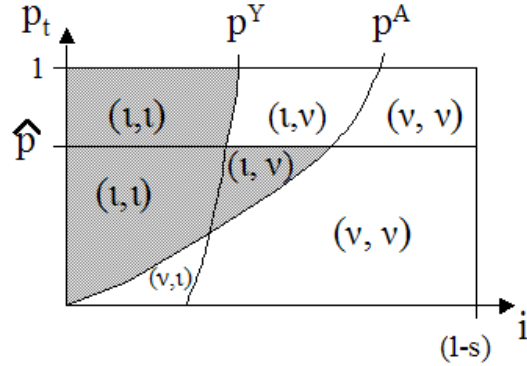

Fig.6. Political choices and outcomes. Shaded areas mean "innovation". In brackets, votes of adult and young.

In figure 6 young are particularly hostile to innovation: only for very small values of  $i$  they vote  $\iota$ . Innovation is ensured, however, for higher values of  $i$  and intermediate values of life expectancy, in the shaded area characterized by the choice vector  $(\iota, \nu)$ : here adults are "dictators" and they choose innovation, against young's will. In figure 7 we again show the function (11) for eight different configurations of parameters: the first (a) is what we call the benchmark, the other seven are graphed changing, one by one, the values of the parameters  $\eta, \alpha, \gamma, \theta, \delta, \epsilon$  and  $s$ .

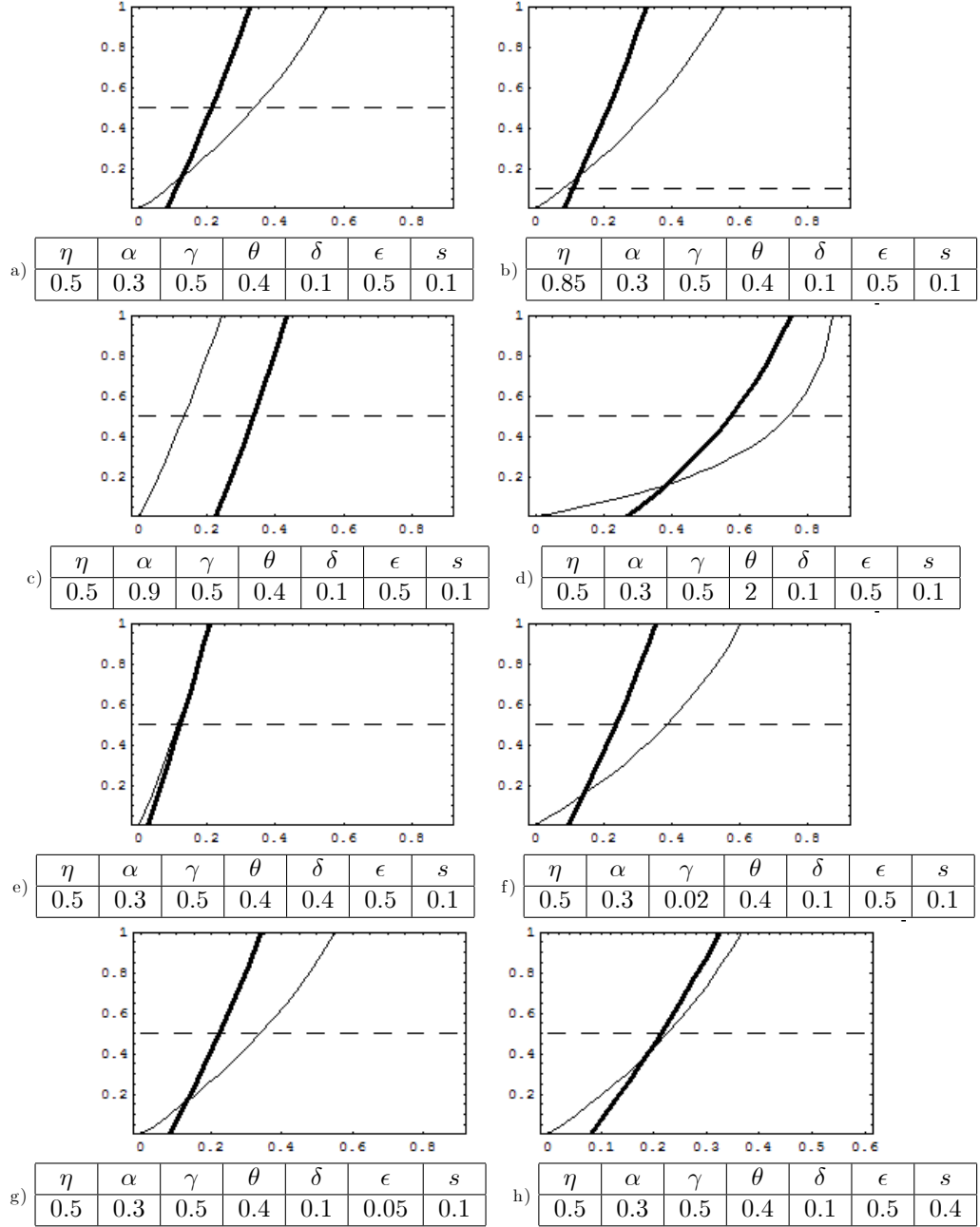

Fig.7. Plots of  $p^A$  (thin line),  $p^Y$  (bold line) and  $\hat{p}$  (dashed line) for different parameters' configurations.



Analyzing fig.6, in case (b) a larger representativeness of young (i.e. higher  $\eta$ ) leads to the vanishing of the region in which adult alone decide for innovation. In case (c) we note that a high concern of adult age consumption leads the two curves  $p^A$  and  $p^Y$  to separate: the former shifts up, the latter shifts down. Moreover, in case the two curves do not intersect, the position of  $\hat{p}$  does not affect the political outcome: adult's threshold binds for all  $(p_t; i)$  pairs, so they have a veto power against young's willingness to innovate. A general result:

**Remark 3** *In the case  $p^A > p^Y : \forall i \in (0, 1 - s)$  the political outcomes in the case of "workers' dictatorship" and "diluted power" are the same.*

Case (d) shows the intuitive effect of an increase in  $\theta$ : both the curves shift down, leading innovation to be preferred for a wide set of  $i$  and  $p_t$ .  $\hat{p}$  does not move and there is room for adult's choice of innovation in early stages of development (i.e. when life expectancy is short). In (e) a higher depreciation rate of human capital in the case of innovation makes both adult and young less favourable to innovate.  $p^Y$  is more sensitive than  $p^A$  to this change: for young a depreciation of human capital reflects in less labour income when adult *and* less pensions when old. A very low elasticity of human capital in the final sector,  $\gamma$  in case (f), makes education almost useless in terms of adulthood income and people choose to work the most of their youth time, see (9), and so innovation is relatively more preferred because it substitutes human capital in production. A decrease in the elasticity of past human capital in the production of human capital,  $\epsilon$  in case (g), shows a similar effect. An increase in the share  $s$  of adult income going to pension contribution (h) leaves unchanged  $p^Y$  and  $\hat{p}$ , while  $p^A$  shifts upward, shrinking the set of  $i$  and  $p_t$  where innovation is implemented.

Resuming the *purely political* stage of the analysis, we can conclude that at *individual* level, people's willingness to innovate increases with life expectancy, the growth rate of innovation itself and, for young, the preference for adult age consumption. Conversely it decreases with the cost of innovation, the depreciation rate of human capital introduced by innovation, the elasticity of human capital in final production and, for adult, the share of income going to paying old people's pensions. Once we turn to the *aggregate* level, that is the political choice implemented, we look, at the same time, to  $p^A$ ,  $p^Y$  and, more important, to  $\hat{p}$ : given the structure of the generations, the economy as a whole chooses to implement a new technology if and only if the majority of its voting inhabitants are in favour of innovation. In the case of  $p_t < \hat{p}$  this maps one to one to the decision of adult, while for values of  $p_t$  above  $\hat{p}$  we need adult and young to be contemporaneously in favour. In the case that, for some configurations of parameters, young are relatively more averse to innovation<sup>14</sup> than adult (i.e. small  $\alpha$ , large  $\theta$ , small  $\gamma$ ), for small values of life expectancy innovation is not implemented, if life expectancy of agents increases a bit, then innovation is implemented without the consensus of young. One more increase in life expectancy can lead again to stop innovation due to the loss of absolute majority

<sup>14</sup>With "more averse" we mean that there are regions of the parameters' space where  $p^Y > p^A$ .

by adult. In the case that a further increase of life expectancy can again bring innovation, then young support innovation and form a coalition with adult. We show this example in the next section, analyzing the political and the economic mechanisms jointly.

## 4 A simple dynamic exercise

In this section we simulate the behavior of an economy characterized by the features described at the end of the section above. The reason is that this example *can* embrace dynamically all the four interesting political configurations described: (i) an aversion to innovation caused by a too short life expectancy; (ii) a short-lived innovation period guaranteed by adult workers' absolute majority; (iii) another period without innovation caused by young's aversion and (iv) again innovation, once the life expectancy is long enough. Since we want to show the possibility of multiple equilibria, we run the simulation for both high and low initial human capital: with same parameters, in the former case the economy reaches, in the end, sustained growth, while in the latter it ends in a poverty trap, with short life expectancy, no innovation and not much education. We make some simplification in order to have easily readable results. First of all we assume that, in the case an innovation takes place, the human capital does not depreciate (i.e.  $\delta = 0$ ). In this way the human capital accumulation function is the same in both the cases of innovation and no innovation. With this assumption, it comes out that the parameter  $\epsilon$  affects only the shape of the human capital accumulation function and not  $p^Y$ . About  $p(h_t)$ , among many functions characterized by a mapping  $[0, \infty) \rightarrow (0, 1]$ , we opt out for the simple, but flexible, specification chosen by Blackburn and Cipriani (2002)<sup>15</sup>:

$$p(h_t) = \frac{p + \bar{p}\phi h_t^\sigma}{1 + \phi h_t^\sigma}, \quad \text{with } \phi, \sigma > 0$$

Where  $\phi$  and  $\sigma$  jointly determine the speed at which the function goes from  $\underline{p}$  to  $\bar{p}$  and the value of  $h_t$  where the function shows the turning point that separates the initial convexity with the concavity that characterize higher levels of  $h_t$ <sup>16</sup>. In line with Blackburn and Cipriani, we choose to set  $\phi = 0.001$ ,  $\sigma = 2$ ,  $\underline{p} = 0.1$  and  $\bar{p} = 1$ .  $\phi$  is bigger than one in order to ensure that  $p''(h)$  is initially positive and then negative, with a turning point in  $h^T = 18.2574$ . The utility function shows  $\alpha = 0.3$ . In the human capital production function  $\lambda = 5$  and  $\epsilon = 0.9$ , while in the production of final good  $\theta = 0.1$ ,  $\gamma = 0.6$  and  $A_0 = 2$ . The share of adult's labour income going to fund pensions is  $s = 0.1$ , while the cost of innovation is a share  $i = 0.1$ . We assume that the political weight of young is  $\eta = 0.5$ .

<sup>15</sup>The authors report a detailed analysis of this function: we suggest referring to their work for all the technicalities.

<sup>16</sup>For a given value of  $\phi(\sigma)$ , an increase (decrease) in  $\sigma(\phi)$  reduces the turning point, while for a given value of such a point, an increase (decrease) in  $\sigma(\phi)$  raises the speed of transition (the limiting case of which is when  $p(\cdot)$  changes value from  $\underline{p}$  to  $\bar{p}$  instantaneously, which corresponds to the case of a step function).

With this setup, the human capital production function shows the features of figure 3. The steady states are four, alternatively unstable and stable:  $h^* = \{0; 0.59; 19.56; 1610.96\}$ . In the case initial human capital is below  $h_0 = 19.56$ , the economy converges, without ever innovating, to a poverty trap where the equilibrium youth time devoted to education is  $e^{*P} = 0.189$ , old age life expectancy *decreases* until  $p^* = 0.100134$ , and human capital level decrease until the lowest stable steady state value 0.59.

In case the initial human capital is above  $h_0 = 19.56$  (which corresponds to an initial life expectancy  $p_0 = 0.349$ ), human capital starts to increase. We refer to figure 8 in order to give a graphical intuition to the explanation.

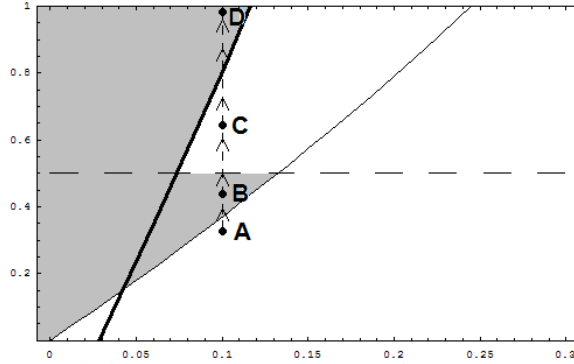

Fig.8. The evolution of life expectancy when  $h_0 > 19.56$ . Shaded areas mean "innovation".

The initial state is point (A): here life expectancy is below both  $p^A$  and  $\hat{p}$ , so adult alone decides not to innovate. Human capital, however, accumulates and life expectancy, in turn, increases. This occurs for some periods, then life expectancy lengthening makes adult prefer innovation (B): the economy experiences some periods during which both human capital and production (the latter at a higher speed than the former) grow. Then life expectancy passes the threshold  $\hat{p}$ : at this time adults lose the absolute majority and young, being against innovation ( $p_t > \hat{p}$ ), force the political outcome to be "no innovation" (C). Here the economy evolves, again showing increases in both human capital and final good production level, but at the same pace. Once young also feels the net benefits of innovation (D), the economy reaches the upper bound of life expectancy  $\bar{p}$ , the higher steady state of human capital  $h^{*H} = 1610.96$ , the schooling time  $e^{*H} = 0.4185$  and the production of final good increases at a rate  $\theta$ .

Of course the aim of this exercise is not to show the real evolution of a given economy, but to understand what the political and economic forces are that lead the economy toward its destiny: to understand the *type* and the *timing* of the policies that need to be implemented is crucial when constraints on human capital accumulation and/or innovation are in place.

## 5 Conclusions

Over the past century, all OECD countries were characterized by a dramatic increase in economic conditions, life expectancy and qualities and quantities of different kinds of knowledge. So, it is natural to suppose that the increase in longevity of citizens is an important factor in determining the life-cycle behaviour of individuals. At the same time, it is unnatural to suppose that life expectancy is exogenous and independent of economic conditions. The purpose of this paper is to provide a theory that explains how an economy might evolve when the longevity of its citizens both influences and is influenced by the process of economic development, especially when choices are upon two dimensions: the *private* choice of education and the *public* one of innovation policy.

Assuming, confidently, that longevity is positively correlated with the level of human capital, the increase of life expectancy that economies are experiencing is, in principle, growth-enhancing. However, its effectiveness can be harmed by, at least, two phenomena. First, building on Blackburn and Cipriani (2002), we reach their same conclusions about the *pure economic* effects of an increase in longevity: due to the positive effect of human capital on expected life expectancy, it can be the case that lower levels of human capital lead to a too short life, and this in turns disincentives people to invest in education, giving rise to a poverty trap. At this stage of development, life expectancy is short and human capital stock is small. Second, we deal with the political features of an economy where the engines of growth are human capital accumulation and *systemic* technologic innovation. Our idea is that, as we are stressing from the introduction onward, a variation in life expectancy affects the individual incentives to innovate and it alters also the aggregate choices of the economy, since political representativeness of different age classes changes. Our argument is that during first stages of development, when human capital is negligible, life expectancy is short and retired people are few, the political power is in the hand of adult workers alone. The decision to innovate or not coincides, therefore, with adult's choice. In the case their incentives to innovate are small (for example a large share of labour income going to finance the PAYGO pension system, a large elasticity of the human capital used in production or a high concern in adult age consumption) they impose to the whole economy a no innovation regime. In developed economies, where life expectancy is higher, human capital endowment is large, life expectancy is long and retired people are several, a political majority that enforces an innovation policy can be achieved only by means of a coalition. Since elderly people are innovation averse, the only way for an innovation to be implemented is that both young and adult are in favour of innovation. Therefore, if on the one hand a longer life expectancy pushes people's incentives toward innovation, on the other hand it makes the political weight of old increase, making the achievement of a consensus for innovation potentially more difficult. This is true, in particular, when young's incentives for innovation are lower than the ones of adult, especially in the case of a high inertia in the transmission of human capital from one generation to the next one and when the concern for adult age consumption is small.

The road that leads to sustained growth is far from being straight: we can find path dependency in the human capital accumulation, because in some cases an initial small amount of human capital can lead to a poverty trap, where the equilibrium longevity is not enough for adult (or adult *and* young in the case of not-so-short life expectancy) to vote for innovation. In case the initial level of human capital is high enough (or there is no room, in the accumulation function of human capital, for multiple equilibria), a high equilibrium level of human capital is achieved, with longer life expectancy. Again, an innovation is voted if and only if both adult *and* young are in favour.

With this paper we provide the basis for joining together two strands of the literature on economic growth that are gaining importance in the research and political debate: technologic innovation and aging population. We stress how different links run between these two phenomena, defining the possible conflict of interests among different generations and showing how the lengthening of life expectancy changes the way this conflict of interests is solved. Moreover, we stress how *private* and *public* choices combine (or not) in order to give birth to a human capital abundant, growing economy.

## References

- [1] Aghion, P., Howitt, P. (1998). *Endogenous Growth Theory*, MIT Press.
- [2] Bauer, M. (1995). *Resistance to New Technology*, Cambridge University Press.
- [3] Bellettini, G., Berti Ceroni, C. (1999). "Is Social Security Really Bad for Growth?," *Review of Economic Dynamics* 2, 796-819.
- [4] Bellettini, G., Ottaviano, G. I. P. (2005). "Special Interest and Technological Change," *Review of Economic Studies* 72, 43-56.
- [5] Blackburn, K., Cipriani, G. P. (2002). "A Model of Longevity, Fertility and Growth," *Journal of Economic Dynamic and Control* 26, 187-204.
- [6] Blackburn, K., Issa, H. (2002). "Endogenous Life Expectancy in a Simple Model of Growth," CGBCR working paper n. 13.
- [7] Boucekkine, R., de la Croix, D., Licandro, O. (2002). "Vintage human capital, demographic trends, and endogenous growth," *Journal of Economic Theory*, 104, 340-375.
- [8] Boucekkine, R., Licandro, O. (2002), Puch, L. A., del Rio, F. (2005). "Vintage Capital and the Dynamics of the AK Model," *Journal of Economic Theory*, 120, 39-72.
- [9] Cervellati, M. Sunde, U. (2005). "Human Capital Formation, Life Expectancy and Process of Economic Development," *American Economic Review* 95, 1653-1672.

- [10] Fogel, R.W. (1994). "Economic Growth, Population Theory and Physiology: The Bearing of Long-Term Process on the Making of Economic Policy," *American Economic Review* 84, 369-395.
- [11] Galasso, V., Profeta, P. (2004). "Politics, Ageing and Pensions," *Economic Policy*, April, 63-115.
- [12] Galor, O. (2005). *Handbook of Economic Growth*, Vol. 1A, edited by P. Aghion and N. Durlauf.
- [13] Galor, O., Weil, D. N. (2000). "Population, Technology and Growth: From Malthusian Stagnation to the Demographic transition and Beyond," *American Economic Review* 90, 807-828.
- [14] Krusell, P., Rios-Rull, J. V. (1996). "Vested Interest in a Positive Theory of Stagnation and Growth," *Review of Economic Studies* 63,301-329.
- [15] Latulippe, D. (1996). "Effective Retirement Age and Duration of Retirement in the Industrial Countries Between 1950 and 1990," *ILO Issues in Social Protection Discussion Paper No. 2*.
- [16] Lee, C. (2001). "The Expected Length of Male Retirement in the United States, 1850-1990," *Journal of Population Economics*, 14, 641-650.
- [17] Lichtenberg, N. P., (1998). "Pharmaceutical Innovation, Mortality Reduction and Economic Growth," *NBER Working Paper*, 6569.
- [18] Lichtenberg, N. P, (2003). "The Impact of New Drugs Launches on Longevity: Evidence from Longitudinal, Disease-Level Data from 52 Countries, 1998-2001," *NBER Working Paper*, 9754.
- [19] Lucas, R. E. (1988). "On the Mechanism of Economic Development," *Journal of Monetary Economics* 22, 3-42.
- [20] Mansell, R. and U. When, (1998). *Knowledge Societies: Information Technology for Sustainable Development*, Oxford University Press.
- [21] Mirowsky, J., Ross, C.E., (1998). "Education, Personal Control, Lifestyle and Health - A Human Capital Hypothesis," *Research on Ageing* 20, 415-449.
- [22] Mokyr, J. (1998a). "The Political Economy of Technological Change: Resistance and Innovation in Economic History," in M. Bergand and K. Bruland (eds.) *Technological Revolutions in Europe* (Cheltenham: Edward Elgar) 39-64.
- [23] Mokyr, J., (1998b). "Induced technical innovation and medical history: an evolutionary approach," *Journal of Evolutionary Economics*, Vol. 8, 119-137.

- [24] Mokyr, J. (2002). "The Gifts of Athena: Historical Origins of the Knowledge Economy" (Princeton University Press) 218-284.
- [25] Olson, M. (1982). The Rise and Decline of Nations-Economic Growth, Stagflation and Social Rigidities, Yale University Press.
- [26] Romer, P. (1986). "Increasing Return and Long Run Growth" Journal of Political Economy 94, 1002-37.
- [27] Schultz, P. T., (1993). "Mortality Decline in the Low-Income World: Causes and Consequences", American Economic Review, 83 (2), 337-342.
- [28] Schultz, P. T., (1998). "Health and Schooling Investments in Africa", Journal of Economic Perspectives, 13 (3), 67-88.